

TMR7503-F

Unibody Low Temperature Coefficient Current Sensor

Description

TMR7503-F is an open loop current sensor for accurate measurement of DC, AC, pulsed current and arbitrary waveform current with galvanic isolation between primary and secondary circuit.



Features and Benefits

- Low temperature coefficient
- High immunity to external interference
- Galvanic isolation
- Excellent linearity
- Light weight and compact
- Extra clearance through busbar
- RoHS & REACH compliant

Applications

- DC motor drives
- Inverters and variable frequency drives (VFD)
- Uninterruptible power supplies (UPS)
- Communication power supplies
- Battery management system (BMS)
- Switching power supplies
- Power supplies for welding application

Selection Guide

Model	Primary Nominal Current	Primary Current Measuring Range
TMR7503-0500F	50 A	±150 A
TMR7503-1000F	100 A	±300 A
TMR7503-2000F	200 A	±600 A
TMR7503-3000F	300 A	±900 A
TMR7503-4000F	400 A	±900 A
TMR7503-5000F	500 A	±900 A
TMR7503-6000F	600 A	±900 A

Insulation and Environmental Characteristics

Parameters	Symbol	Typical	Unit
Dielectric Strength	V_D	5	kV(50Hz, 1min)
Insulation Resistance	R_{IS}	1000	MΩ
Creepage Distance	d_{CP}	5	mm
Clearance	d_{CL}	4.5	mm
Ambient Operating Temperature	T_A	-40 to +105	°C
Ambient Storage Temperature	T_{STG}	-50 to +125	°C
Mass	m	61	g

Catalogue

1. Specifications	03
2. Typical Output Characteristics	04
3. Typical Temperature Characteristics	05
4. Parameters Definition And Formula.....	07
5. Application Information	08
6. Dimensions	09

1. Specifications

$T_A = +25\text{ }^\circ\text{C}$, $V_{CC} = \pm 15\text{ V}$, $R_L = 10\text{ k}\Omega$, unless otherwise noted

Parameter	Symbol	Condition	Min.	Typ.	Max.	Unit	
General Electrical Data							
Primary Nominal Current	I_{PN}	TMR7503-0500F	-	50	-	A	
		TMR7503-1000F	-	100	-		
		TMR7503-2000F	-	200	-		
		TMR7503-3000F	-	300	-		
		TMR7503-4000F	-	400	-		
		TMR7503-5000F	-	500	-		
		TMR7503-6000F	-	600	-		
Primary Current Measuring Range	I_{PM}	TMR7503-0500F	-150	-	150	A	
		TMR7503-1000F	-300	-	300		
		TMR7503-2000F	-600	-	600		
		TMR7503-3000F	-900	-	900		
		TMR7503-4000F	-900	-	900		
		TMR7503-5000F	-900	-	900		
		TMR7503-6000F	-900	-	900		
Sensitivity	S	$I_P = 0\text{ to } \pm I_{PN}$	TMR7503-0500F	-	80.00	-	mV/A
			TMR7503-1000F	-	40.00	-	
			TMR7503-2000F	-	20.00	-	
			TMR7503-3000F	-	13.33	-	
			TMR7503-4000F	-	10.00	-	
			TMR7503-5000F	-	8.00	-	
			TMR7503-6000F	-	6.67	-	
Output Voltage	V_{OUT}	$I_P = 0\text{ to } \pm I_{PM}$	-	$V_{OE} + S \times I_P$	-	V	
Supply Voltage	V_{CC}	$\pm 5\%$	-	± 15	-	V	
Current Consumption	I_C	$I_P = 0$	-	± 20	-	mA	
Load Resistance	R_L	$I_P = 0\text{ to } \pm I_{PN}$	1	10	-	k Ω	
Load Capacitance	C_L	$I_P = 0\text{ to } \pm I_{PN}$	-	100	-	pF	
Static Performance Data							
Accuracy	X_G	$T_A = +25\text{ }^\circ\text{C}$, $I_P = 0\text{ to } \pm I_{PN}$	-1	± 0.5	1	% I_{PN}	
		$T_A = -40\text{ }^\circ\text{C to } +105\text{ }^\circ\text{C}$, $I_P = 0\text{ to } \pm I_{PN}$	-3.5	± 1.5	3.5		
Linearity Error	ϵ_L	$T_A = -40\text{ }^\circ\text{C to } +105\text{ }^\circ\text{C}$, $I_P = 0\text{ to } \pm I_{PN}$	-	0.4	0.8	% I_{PN}	
Symmetry	ϵ_{SYM}	$T_A = -40\text{ }^\circ\text{C to } +105\text{ }^\circ\text{C}$, $I_P = 0\text{ to } \pm I_{PN}$	99	100	101	%	
Sensitivity Error	ϵ_S	$T_A = -40\text{ }^\circ\text{C to } +105\text{ }^\circ\text{C}$, $I_P = 0\text{ to } \pm I_{PN}$	-2	-	2	%	
Offset Error	V_{OE}	$T_A = +25\text{ }^\circ\text{C}$, $I_P = 0$	-20	± 10	20	mV	
		$T_A = -40\text{ }^\circ\text{C to } +105\text{ }^\circ\text{C}$, $I_P = 0$	-60	± 20	60		
Hysteresis	V_{OH}	$T_A = -40\text{ }^\circ\text{C to } +105\text{ }^\circ\text{C}$, $I_P = \pm I_{PN} \rightarrow 0$	-20	± 10	20	mV	
Dynamic Performance Data							
Response Time	t_R	$di/dt > 50\text{ A}/\mu\text{s}$, 10% to 90% of I_{PN}	-	1	-	μs	
Bandwidth	BW	-3 dB	DC	180	-	kHz	

2. Typical Output Characteristics

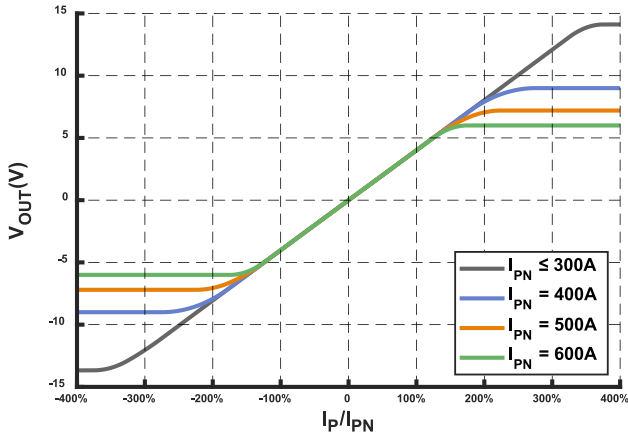

Figure 1. Output voltage versus primary current

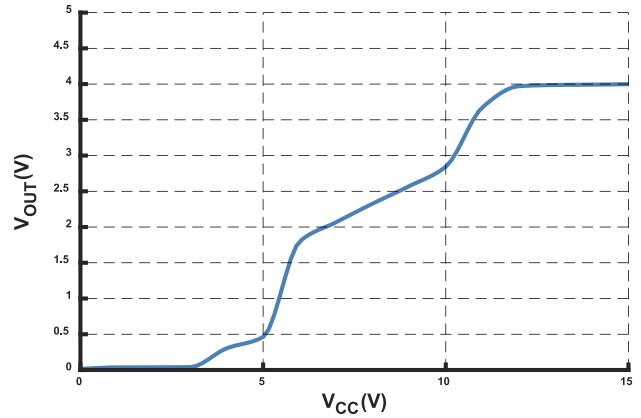

Figure 2. Output voltage versus supply voltage

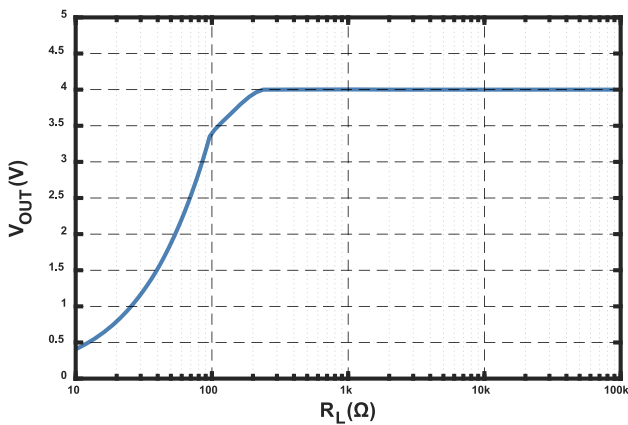

Figure 3. Output voltage versus load resistance
(@ $I_P = I_{PN}$)

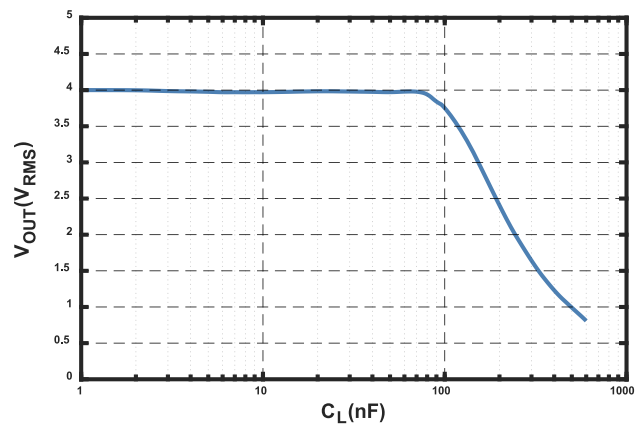

Figure 4. Output voltage versus load capacitance
(@ $I_P = I_{PN}$)

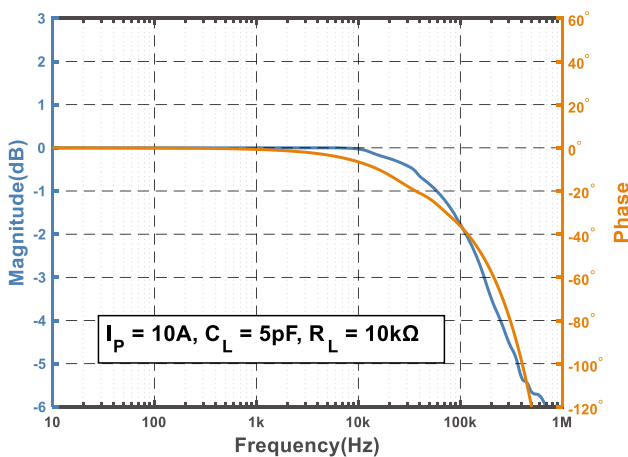

Figure 5. Bode plot of TMR7503-F

3. Typical Temperature Characteristics

AVG+3 σ
 AVG
 AVG-3 σ

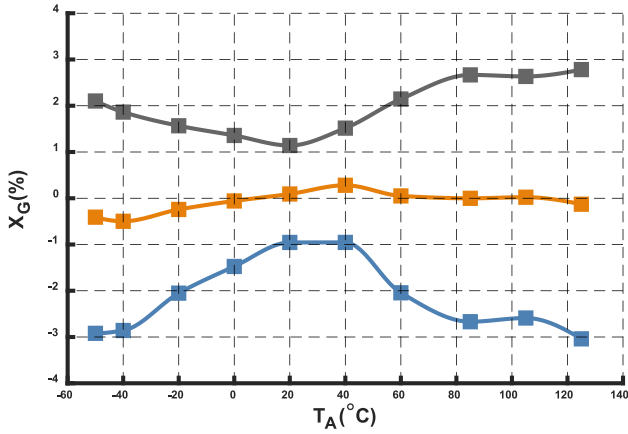

Figure 6. Total error versus ambient temperature

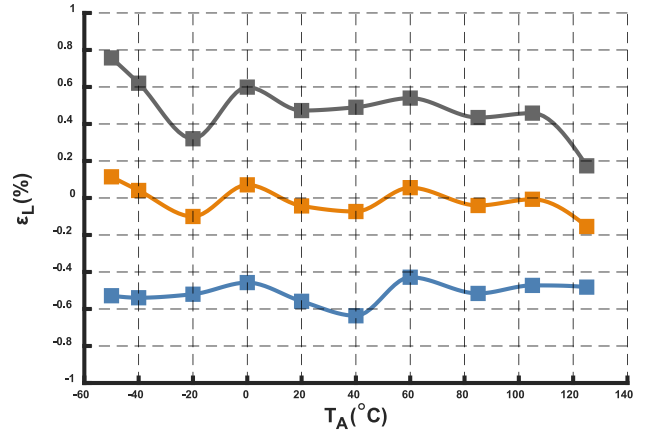

Figure 7. Linearity error versus ambient temperature

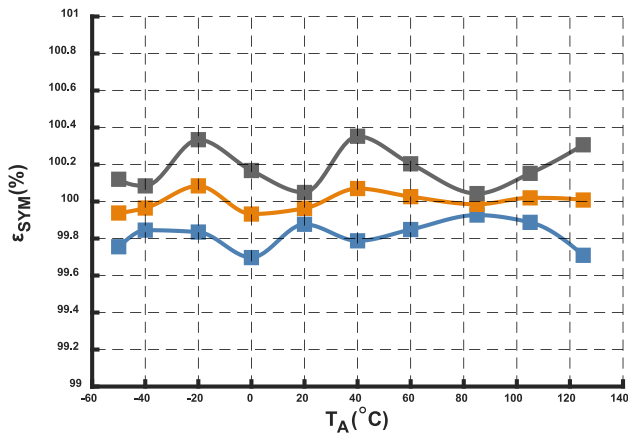

Figure 8. Symmetry versus ambient temperature

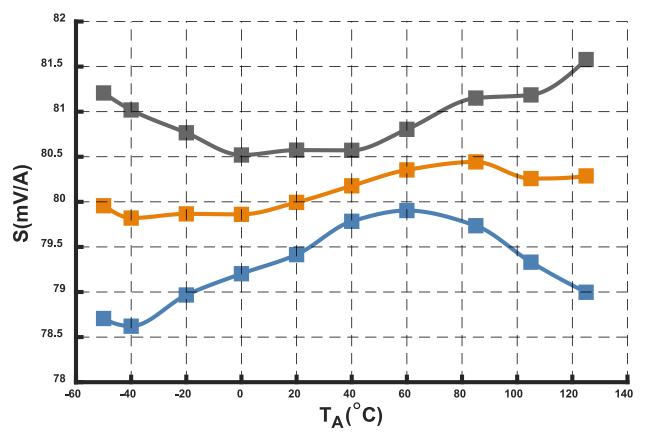

Figure 9. Sensitivity @ $I_{PN} = 50$ A versus ambient temperature

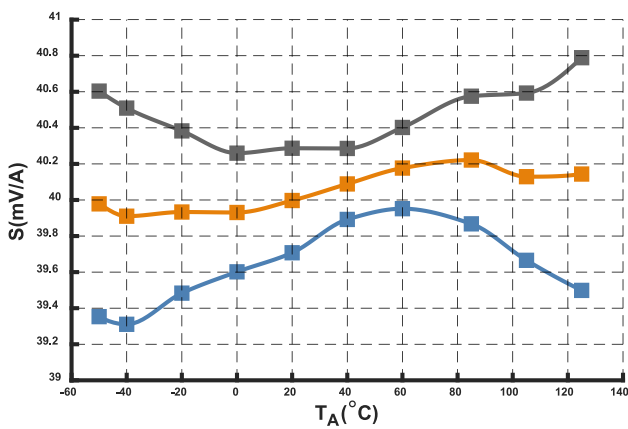

Figure 10. Sensitivity @ $I_{PN} = 100$ A versus ambient temperature

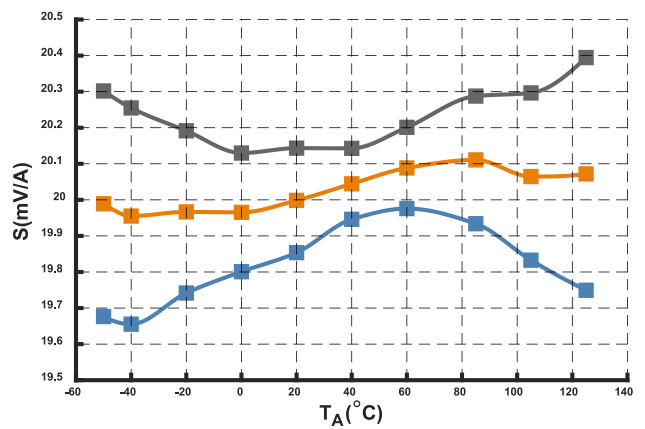

Figure 11. Sensitivity @ $I_{PN} = 200$ A versus ambient temperature

Typical Temperature Characteristics

AVG+3σ AVG AVG-3σ

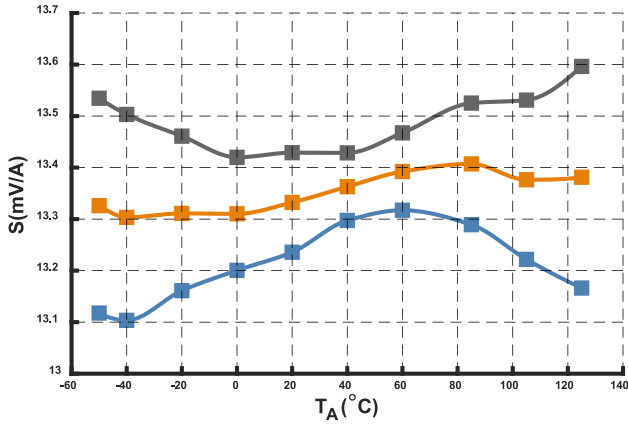

Figure 12. Sensitivity @ $I_{PN} = 300$ A versus ambient temperature

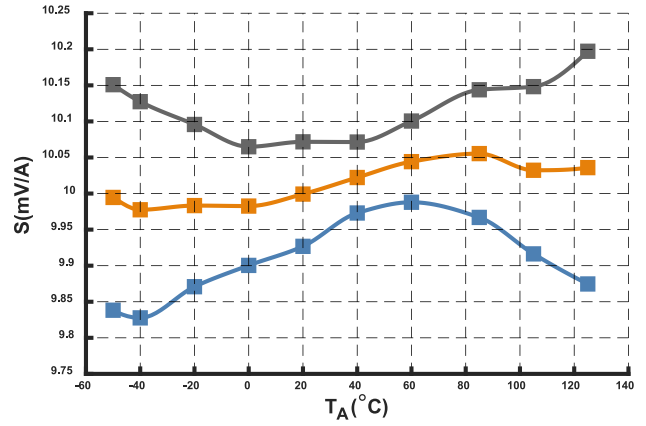

Figure 13. Sensitivity @ $I_{PN} = 400$ A versus ambient temperature

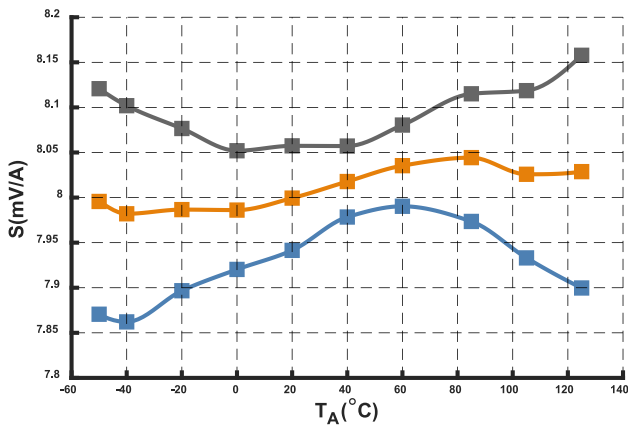

Figure 14. Sensitivity @ $I_{PN} = 500$ A versus ambient temperature

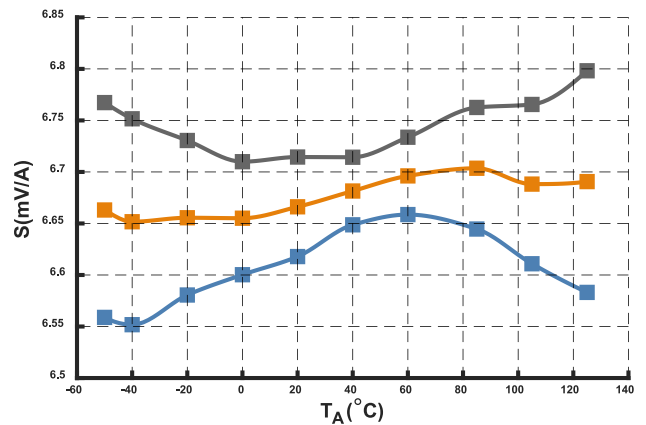

Figure 15. Sensitivity @ $I_{PN} = 600$ A versus ambient temperature

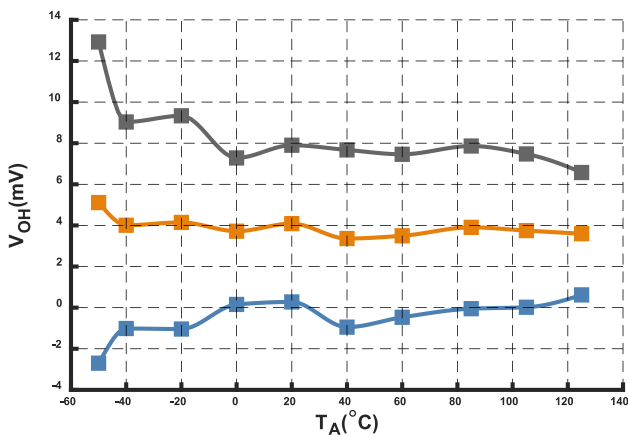

Figure 16. Hysteresis versus ambient temperature

4. Parameters Definition And Formula

1) Output Voltage

$$V_{OUT} = V_{OE} + S \times I_P$$

V_{OUT} stands for current sensor output voltage at given primary current, V_{OE} stands for offset error, S stands for sensitivity, I_P stands for primary current.

2) Accuracy

$$X_G = \text{MAX}_{I_P \in [-I_{PN}, I_{PN}]} \left(\frac{V_{OUT} - (S \times I_P)}{S \times I_{PN}} \times 100\% \right)$$

I_{PN} stands for nominal primary current

3) Sensitivity

$$S = \frac{V_{OUT(@ I_{PN})} - V_{OUT(@ -I_{PN})}}{2 \times I_{PN}}$$

$V_{OUT(@ I_{PN})}$ and $V_{OUT(@ -I_{PN})}$ stand for the voltage output at I_{PN} and $-I_{PN}$ respectively.

4) Linearity

$$\varepsilon_L = \text{MAX}_{I_P \in [-I_{PN}, I_{PN}]} \left(\frac{V_{OUT} - (\bar{V}_{OE} + \bar{S} \times I_P)}{S \times I_{PN}} \times 100\% \right)$$

\bar{S} and \bar{V}_{OE} stand for the average values of the sensitivity and offset error.

5) Symmetry

$$\varepsilon_{SYM} = \left| \frac{V_{OUT(@ I_{PN})} - \bar{V}_{OE}}{V_{OUT(@ -I_{PN})} - \bar{V}_{OE}} \right| \times 100\%$$

6) Hysteresis

$$V_{OH} = \text{MAX } \Delta H$$

ΔH is the maximum residual voltage between full scale positive and negative nominal current.

5. Application Information

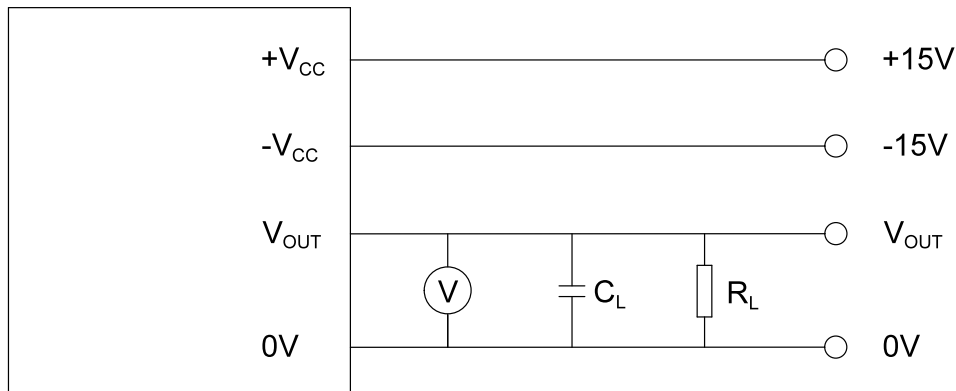

Figure 17. Connection diagram of TMR7503

Mounting Recommendation

1. Mounting method: 3 × Φ 4.5 mm holes (pick one)
1 × M4 copper or SS304 screw (recommended applied torque 0.75 N•m)
2. Primary through-hole dimensions: 20 mm × 10 mm
3. Secondary terminal: Molex 22041041 (previous 5045-04A series)
Crimp Housing: Molex 22011042, Crimping Terminal: Molex 08500113

Remarks

1. V_{OUT} is positive when the primary current is in the same direction as the arrow indication on the label and vice versa.
2. Improper connection can cause permanent damage of the sensor.
3. Excessive capacitive load may result in distortion of output signals when measuring high frequency primary signal. Please refer to Output Voltage vs Load Capacitance Curve.
4. Sensor is customizable upon request.
5. Dynamic performances (di/dt and response time) are best with a single busbar completely filling the primary hole.

6. Dimensions

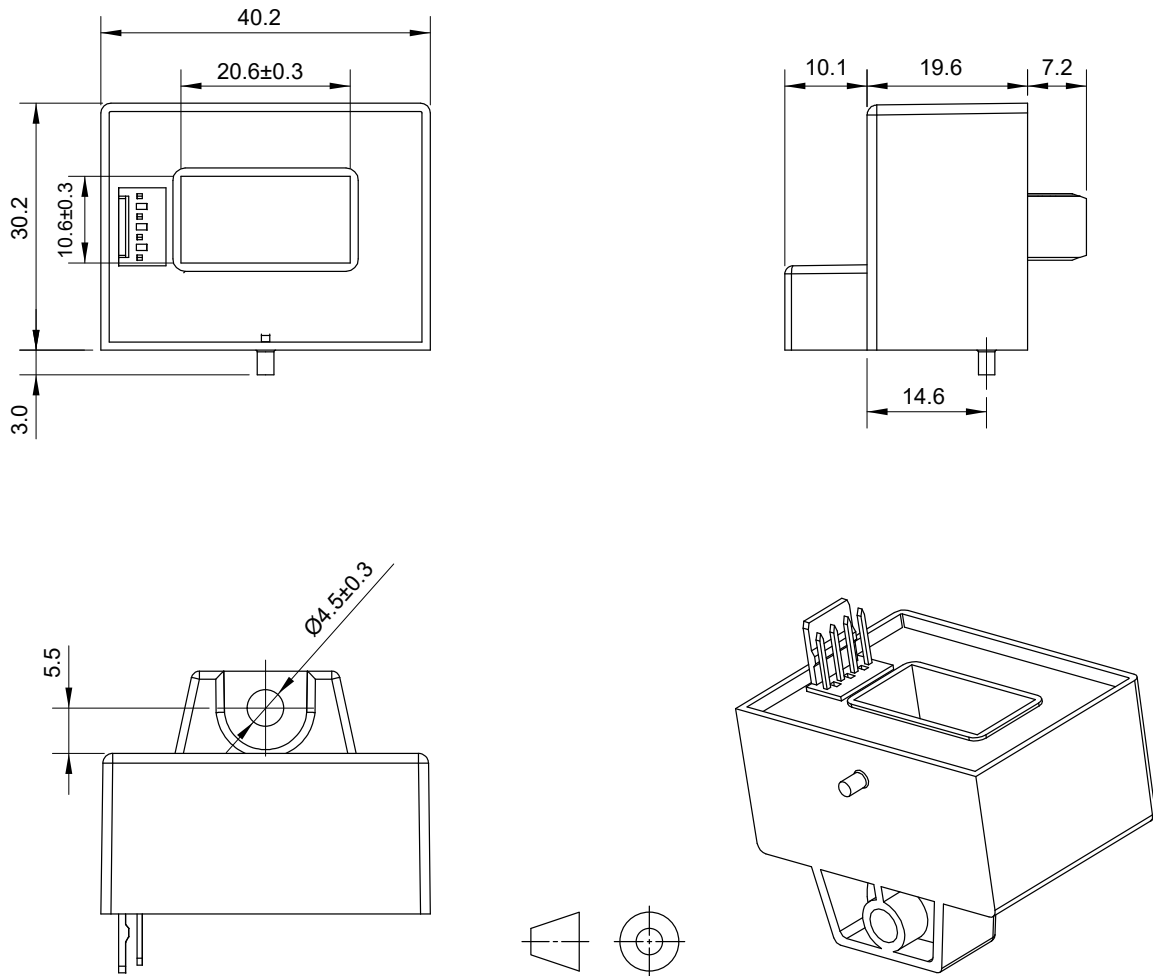

Figure 18. Sensor outline (unit: mm, tolerances for unmarked scales ± 1 mm)

Copyright © 2024 by MultiDimension Technology Co., Ltd.

Information furnished herein by MultiDimension Technology Co., Ltd. (hereinafter MDT) is believed to be accurate and reliable. However, MDT disclaims any and all warranties and liabilities of any kind, with respect to any examples, hints or any performance or use of technical data as described herein and/or any information regarding the application of the product, including without limitation warranties of non-infringement of intellectual property rights of any third party. This document neither conveys nor implies any license under patent or other industrial or intellectual property rights. Customer or any third-party must further determine the suitability of the MDT products for its applications to avoid the applications default of customer or third-party. MDT accept no liability in this respect.

MDT does not assume any liabilities of any indirect, incidental, punitive, special or consequential damages (including without limitation of lost profits, lost savings, business interruption, costs related to the removal or replacement of any products or rework charges) whether or not such damages are based on tort (including negligence), warranty, breach of contract or any other legal theory. Notwithstanding any damages that customer might incur for any reason whatsoever, MDT's aggregate and cumulative liability towards customer for the products described herein shall be limited in accordance with the terms and conditions of commercial sale of MDT.

Absolute maximum ratings are the extreme limits the device will withstand without damage to the MDT product. However, the electrical and mechanical characteristics are not guaranteed as the maximum limits (above recommended operating conditions) are approached. MDT disclaims any and all warranties and liabilities of the MDT product will operate at absolute maximum ratings.

Specifications may change without notice.

Please download latest document from our official website www.dowaytech.com/en.

Recycling

The product(s) in this document need to be handed over to a qualified solid waste management services company for recycling in accordance with relevant regulations on waste classification after the end of the product(s) life.



No.2 Guangdong Road, Zhangjiagang Free Trade Zone, Jiangsu, China

Web: www.dowaytech.com/en E-mail: info@dowaytech.com

