

TMR130x

MicroAmpere High Frequency Response Omnipolar Magnetic Switch Sensor

Description

TMR130x is an omnipolar magnetic switch integrated the tunnel magnetoresistance (TMR) magnetic sensor and CMOS circuitry, which is able to detect the change of magnetic field and output high and low voltage signals for high accuracy position detection.

Unlike Hall/AMR sensors, TMR sensors with extremely high resistance values allows TMR130x to achieve the supply current as low as 1.5 μA while operating in the full-time power supply mode, and maintaining the response frequency of the magnetic signal is greater than 1 kHz. Therefore, TMR130x can provide true continuous detection of magnetic field signals, avoiding sampling errors from the traditional time-sharing power supply mode.

TMR130x allows a wide range of operating supply voltages from 1.8 V to 5.5 V with excellent temperature characteristics, and can meet the requirements of most applications.

TMR130x is available in two compact SOT23-3 and TO92S packages.

Features and Benefits

- Tunneling magnetoresistance (TMR) technology
- Low power consumption: supply current 1.5 μA
- High frequency response: >1 kHz
- Omnipolar operation
- Wide range supply voltages: 1.8 V to 5.5 V
- CMOS push-pull output
- High sensitivity
- Excellent temperature stability
- High tolerance to external magnetic field interference
- RoHS & REACH compliant

Applications

- Utility meters: water, gas, and heat meters
- Proximity switches
- Speed sensing
- Linear and rotation position sensing

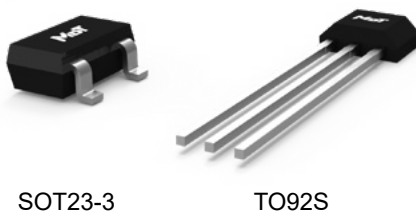

SOT23-3

TO92S

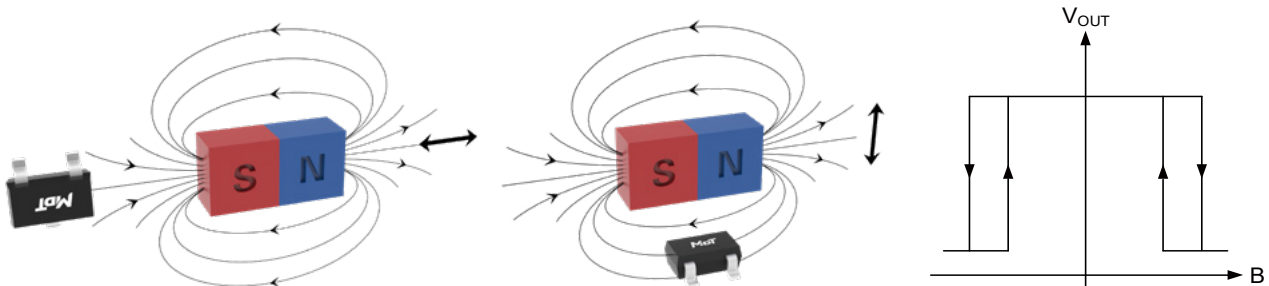

Selection Guide

Part Number	Supply Current	Response Frequency	Operating Ambient Temperature	Operating Point	Release Point	Package	Packing Form
TMR1302S	1.5 μ A	1 kHz	-40 °C to 125 °C	\pm 17 Gs	\pm 10 Gs	SOT23-3	Tape & Reel
TMR1302T	1.5 μ A	1 kHz	-40 °C to 125 °C	\pm 17 Gs	\pm 10 Gs	TO92S	ESD Bag
TMR1302HS	1.5 μ A	5 kHz	-40 °C to 125 °C	\pm 17 Gs	\pm 10 Gs	SOT23-3	Tape & Reel
TMR1302HT	1.5 μ A	5 kHz	-40 °C to 125 °C	\pm 17 Gs	\pm 10 Gs	TO92S	ESD Bag
TMR1302HTS	1.5 μ A	5 kHz	-40 °C to 150 °C	\pm 17 Gs	\pm 10 Gs	SOT23-3	Tape & Reel
TMR1302HTT	1.5 μ A	5 kHz	-40 °C to 150 °C	\pm 17 Gs	\pm 10 Gs	TO92S	ESD Bag
TMR1303S	1.5 μ A	1 kHz	-40 °C to 125 °C	\pm 35 Gs	\pm 22 Gs	SOT23-3	Tape & Reel
TMR1303T	1.5 μ A	1 kHz	-40 °C to 125 °C	\pm 35 Gs	\pm 22 Gs	TO92S	ESD Bag
TMR1304S	1.5 μ A	1 kHz	-40 °C to 125 °C	\pm 10 Gs	\pm 5 Gs	SOT23-3	Tape & Reel
TMR1304T	1.5 μ A	1 kHz	-40 °C to 125 °C	\pm 10 Gs	\pm 5 Gs	TO92S	ESD Bag
TMR1308S	1.5 μ A	1 kHz	-40 °C to 125 °C	\pm 5 Gs	\pm 3 Gs	SOT23-3	Tape & Reel
TMR1308T	1.5 μ A	1 kHz	-40 °C to 125 °C	\pm 5 Gs	\pm 3 Gs	TO92S	ESD Bag

Note: Please contact MultiDimension Technology local sales for customizing operating and release points.

Catalogue

1. Functional Block Diagram.....	03
2. Switching Characteristics	03
3. Pin Configuration	03
4. Absolute Maximum Ratings	04
5. Electrical Specifications.....	04
6. Magnetic Specifications.....	04
7. Typical Supply Voltage Characteristics.....	06
8. Typical Temperature Characteristics	07
9. Application Information	09
10. Dimensions.....	10

1. Functional Block Diagram

TMR130x series switch chips are composed of TMR sensors and signal processing circuits. The TMR sensor detects external magnetic field, generates an analog voltage signal, and outputs a logical switch level after processing by the circuits as shown in Figure 1.

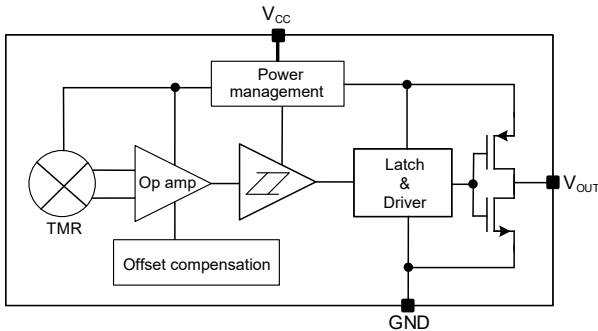

Figure 1. Block diagram

2. Switching Characteristics

The TMR130x sensing axis is parallel to the package top-marking surface; the sensing axis is defined from the N pole toward the S pole, as indicated by the arrow in the figure below.

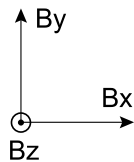

Figure 2-1. Definition of axis

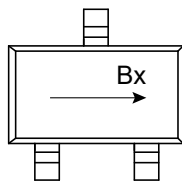

Figure 2-2. Axial diagram (SOT23-3 top view)

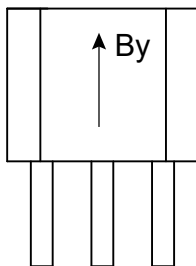

Figure 2-3. Axial diagram (TO92S side view)

The output is “High”, when power is on at zero magnetic field. B is the external magnetic field along the sensing direction, B_{OPS} (B_{OPN}) is the operating point, B_{RPS} (B_{RPN}) is the release point, and hysteresis B_H is define as the difference between B_{OPS} and B_{RPS} (B_{OPN} and B_{RPN}).

The sensor outputs a low level, when the magnetic field along the sensing axis exceeds the operate point B_{OPS} (B_{OPN}), and the device outputs a high level, when the magnetic field is reduced below the release point B_{RPS} (B_{RPN}) as shown in Figure 3.

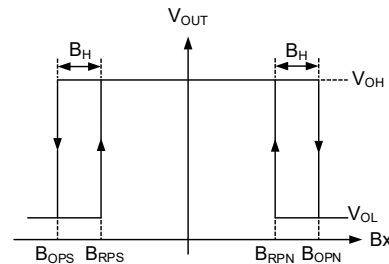

Figure 3-1. Switching characteristics (SOT23-3)

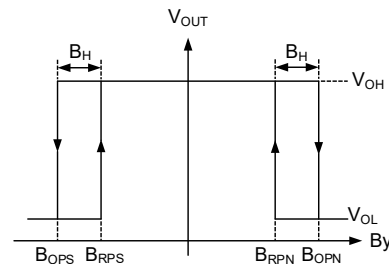

Figure 3-2. Switching characteristics (TO92S)

3. Pin Configuration

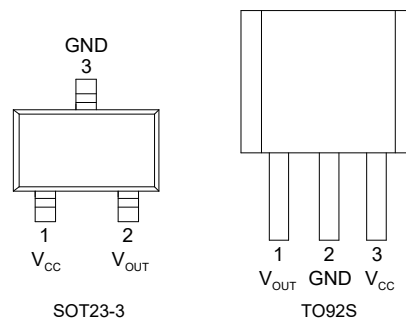

Figure 4. Pin configuration

Pin Number		Name	Function
SOT23-3	TO92S		
1	3	V_{CC}	Power supply
2	1	V_{OUT}	Output
3	2	GND	Ground

4. Absolute Maximum Ratings

Parameters	Symbol	Min.	Max.	Unit	Applicable Part Number
Supply voltage	V_{CC}	-0.3	7	V	All parts
Output current	I_{SINK} and I_{SOURCE}	-	9	mA	All parts
Magnetic flux density	B	-	4000	Gs	All parts
ESD performance (HBM)	V_{ESD}	-	4	kV	All parts
Operating ambient temperature	T_A	-40	125	°C	All parts
		-50	150	°C	TMR1302HTx
Storage ambient temperature	T_{STG}	-50	150	°C	All parts

Note: I_{SINK} is the current flowing through the high side MOSFET, when the high side MOSFET is turned on, and I_{SOURCE} is the current flowing through the low side MOSFET when the low side MOSFET is turned on.

5. Electrical Specifications

$V_{CC} = 3\text{ V}$, $T_A = 25\text{ °C}$, a 0.1 μF capacitor is connected between V_{CC} and GND

Parameter	Symbol	Condition	Min.	Typ.	Max.	Unit	Applicable Part Number
Supply voltage	V_{CC}	operating	1.8	3.0	5.5	V	All parts
Output high voltage	V_{OH}	RP status	$V_{CC}-0.3$	-	V_{CC}	V	All parts
Output low voltage	V_{OL}	OP status	0	-	0.2	V	All parts
Supply current	I_{CC}	output open	0.5	1.5	2	μA	All parts
Response frequency	F	-	0 to 1000			Hz	All parts
			0 to 5000			Hz	TMR1302Hx, TMR1302HTx

6. Magnetic Specifications

$V_{CC} = 3\text{ V}$, $T_A = 25\text{ °C}$, a 0.1 μF capacitor is connected between V_{CC} and GND

TMR1302x, TMR1302Hx, TMR1302HTx

Parameter	Symbol	Min.	Typ.	Max.	Unit
Operate point	B_{OPN}	10	17	25	Gs
	B_{OPS}	-25	-17	-10	Gs
Release point	B_{RPN}	5	10	20	Gs
	B_{RPS}	-20	-10	-5	Gs
Hysteresis	B_H	3	-	16	Gs

TMR1303x

Parameter	Symbol	Min.	Typ.	Max.	Unit
Operate point	B _{OPN}	23	35	47	Gs
	B _{OPS}	-47	-35	-23	Gs
Release point	B _{RPN}	10	22	40	Gs
	B _{RPS}	-40	-22	-10	Gs
Hysteresis	B _H	3	-	16	Gs

TMR1304x

Parameter	Symbol	Min.	Typ.	Max.	Unit
Operate point	B _{OPN}	6	10	14	Gs
	B _{OPS}	-14	-10	-6	Gs
Release point	B _{RPN}	3	5	10	Gs
	B _{RPS}	-10	-5	-3	Gs
Hysteresis	B _H	2	-	7	Gs

TMR1308x

Parameter	Symbol	Min.	Typ.	Max.	Unit
Operate point	B _{OPN}	3	5	9	Gs
	B _{OPS}	-9	-5	-3	Gs
Release point	B _{RPN}	2.5	3	7	Gs
	B _{RPS}	-7	-3	-2.5	Gs
Hysteresis	B _H	0.5	-	6.5	Gs

7. Typical Supply Voltage Characteristics

TMR1302x, TMR1302Hx, TMR1302HTx Supply Voltage Characteristics

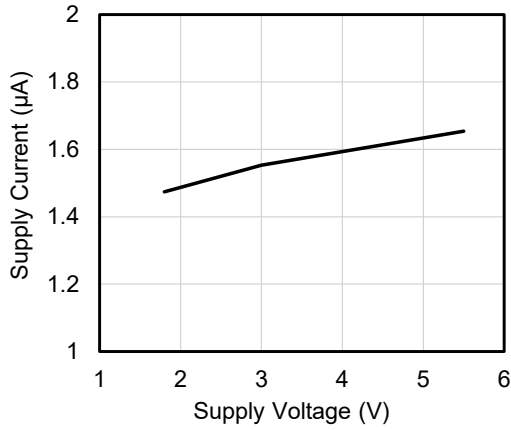

Figure 5. Supply current versus supply voltage (T_A=25°C)

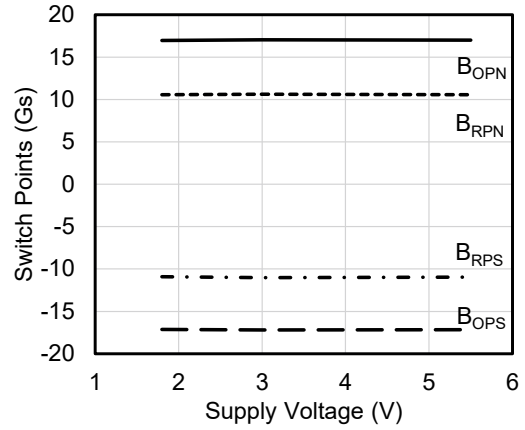

Figure 6. Switch points versus supply voltage (T_A=25°C)

TMR1303x Supply Voltage Characteristics

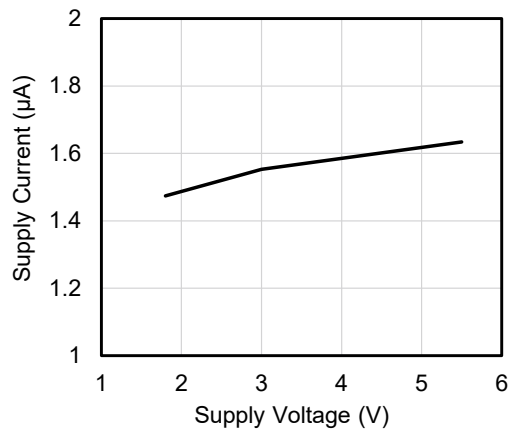

Figure 7. Supply current versus supply voltage (T_A=25°C)

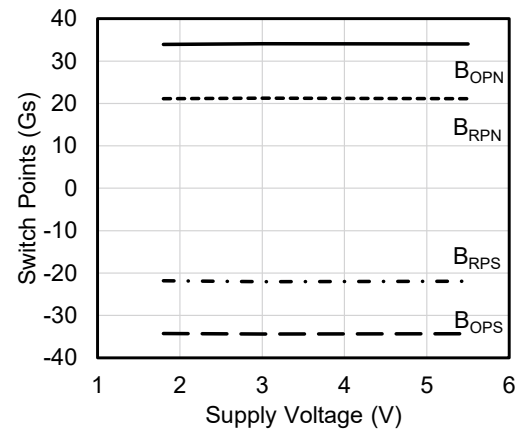

Figure 8. Switch points versus supply voltage (T_A=25°C)

TMR1304x Supply Voltage Characteristics

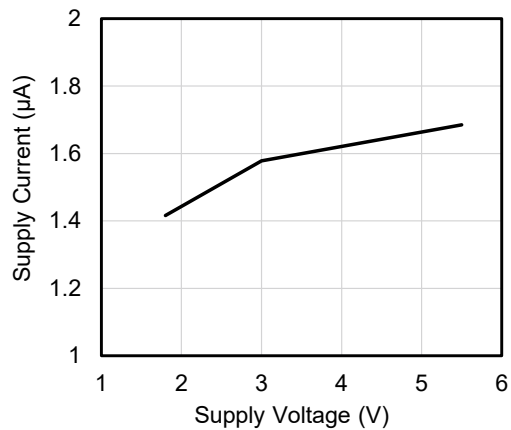

Figure 9. Supply current versus supply voltage (T_A=25°C)

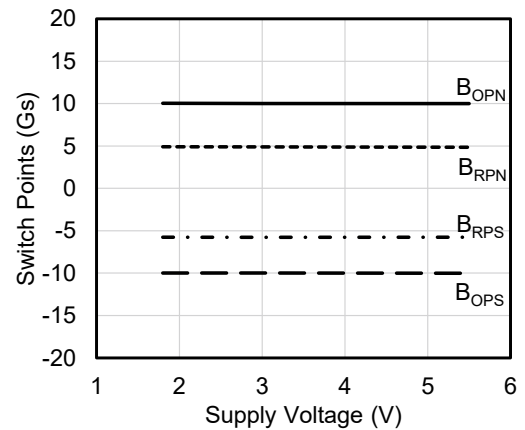

Figure 10. Switch points versus supply voltage (T_A=25°C)

TMR1308x Supply Voltage Characteristics

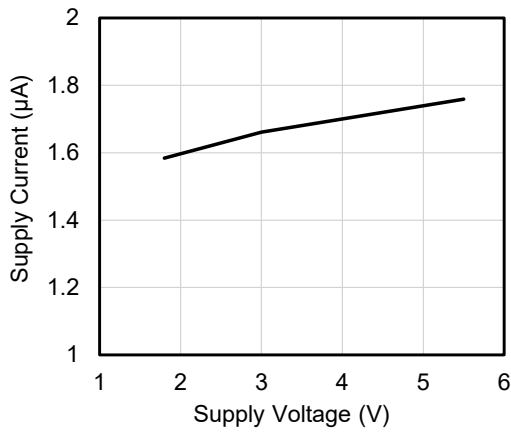

Figure 11. Supply current versus supply voltage ($T_A=25^\circ\text{C}$)

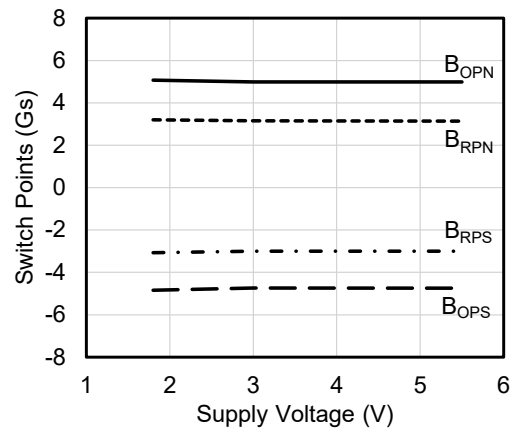

Figure 12. Switch points versus supply voltage ($T_A=25^\circ\text{C}$)

8. Typical Temperature Characteristics

TMR1302x, TMR1302Hx Temperature Characteristics

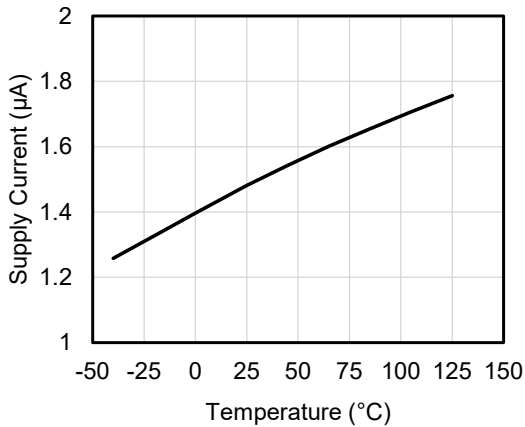

Figure 13. Supply current versus temperature ($V_{CC} = 3\text{ V}$)

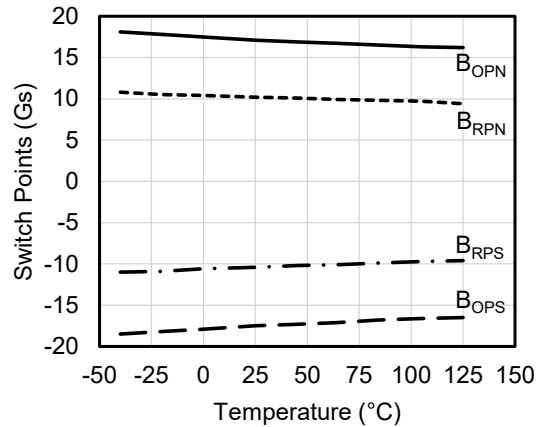

Figure 14. Switch points versus temperature ($V_{CC} = 3\text{ V}$)

TMR1302HTx Temperature Characteristics

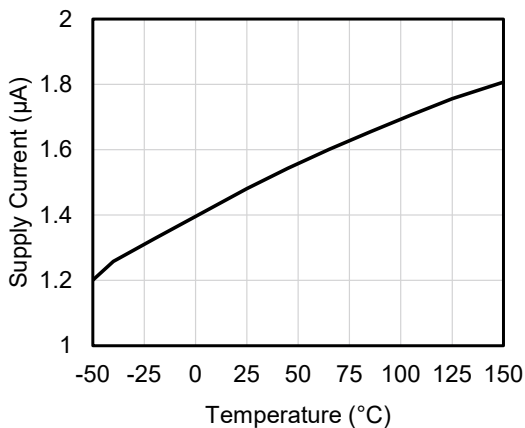

Figure 15. Supply current versus temperature ($V_{CC} = 3\text{ V}$)

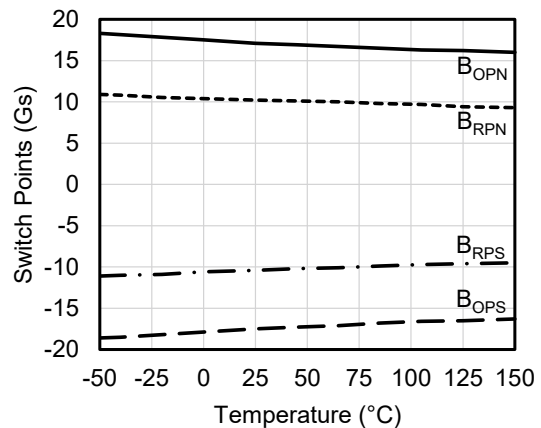

Figure 16. Switch points versus temperature ($V_{CC} = 3\text{ V}$)

TMR1303x Temperature Characteristics

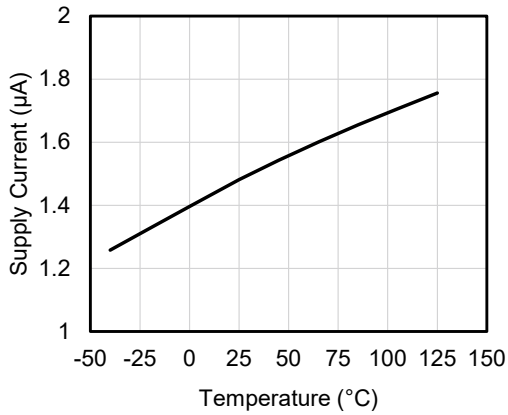

Figure 17. Supply current versus temperature ($V_{CC} = 3\text{ V}$)

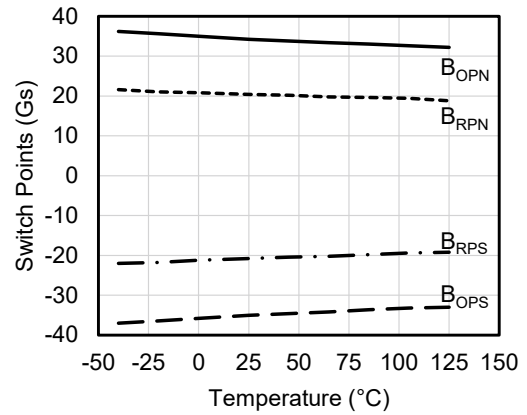

Figure 18. Switch points versus temperature ($V_{CC} = 3\text{ V}$)

TMR1304x Temperature Characteristics

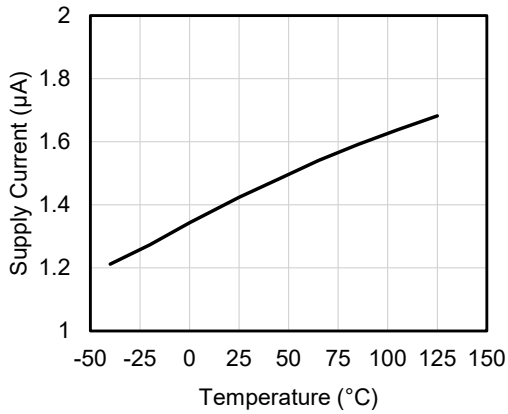

Figure 19. Supply current versus temperature ($V_{CC} = 3\text{ V}$)

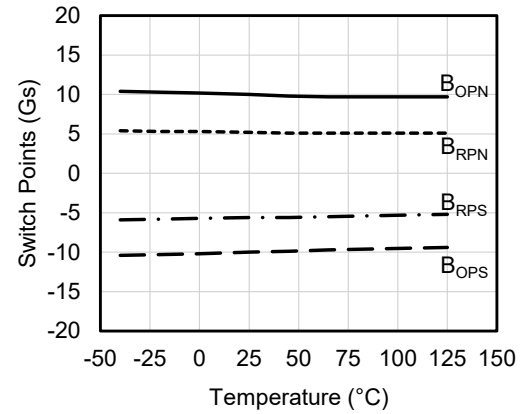

Figure 20. Switch points versus temperature ($V_{CC} = 3\text{ V}$)

TMR1308x Temperature Characteristics

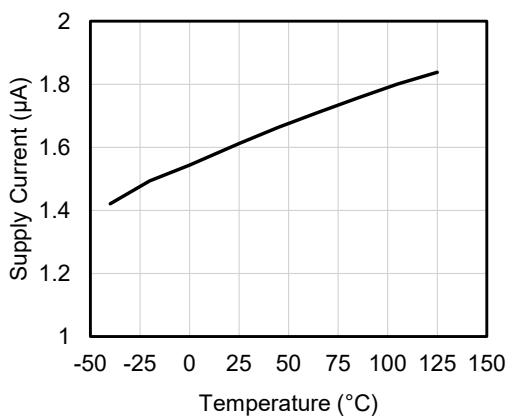

Figure 21. Supply current versus temperature ($V_{CC} = 3\text{ V}$)

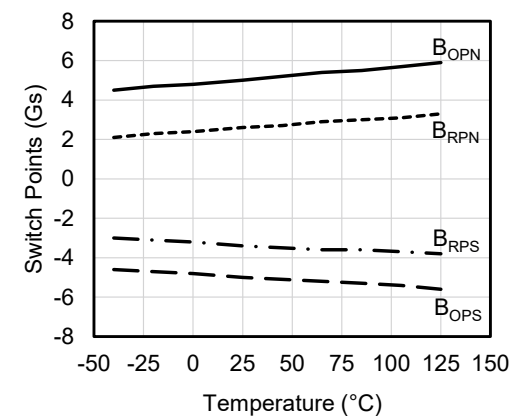

Figure 22. Switch points versus temperature ($V_{CC} = 3\text{ V}$)

9. Application Information

It is recommended to add a filter capacitor between the sensor power supply and ground (close to the sensor) to reduce external noise. As shown in Figure 23, the typical value is 0.1 μF .

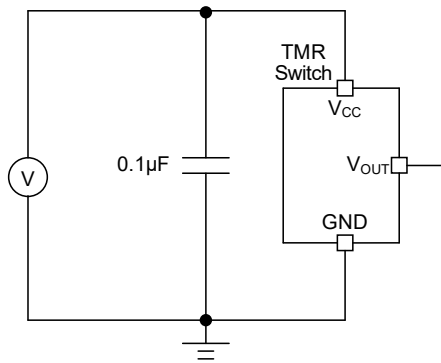

Figure 23. Application circuit diagram

The TMR130x series sensor chips are not suitable for driving power loads. The general method of use is utilizing the output voltage of V_{OUT} pin as a signal to input the MCU or drive a triode or MOS as shown in Figure 24.

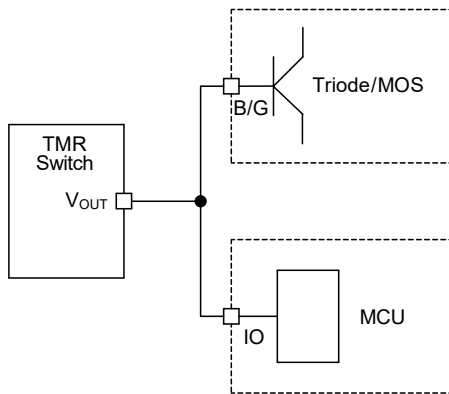

Figure 24. Application diagram for driving power load

Common failure conditions:

- The device is exposed to conditions exceeding any absolute maximum rating.
- The external circuit does not include properly matched supply-pin decoupling/filter capacitors.
- The device's V_{OUT} pin is used to directly drive power devices (e.g., relays), causing the output current to exceed the "Absolute Maximum Ratings".
- The device operates in a humid environment for an extended period.
- The maximum soldering temperature exceeds 260°C, or exposure above 250°C lasts longer than 10s.
- The device is exposed to temperatures above the maximum operating temperature while the external magnetic field exceeds 20 Gs.
- The device is exposed to an ultrasonic environment.
- Excessive deformation of the device leads/pins.
- Applying a voltage to the V_{OUT} pin, or powering the device through the V_{OUT} pin.

10. Dimensions

SOT23-3 Package

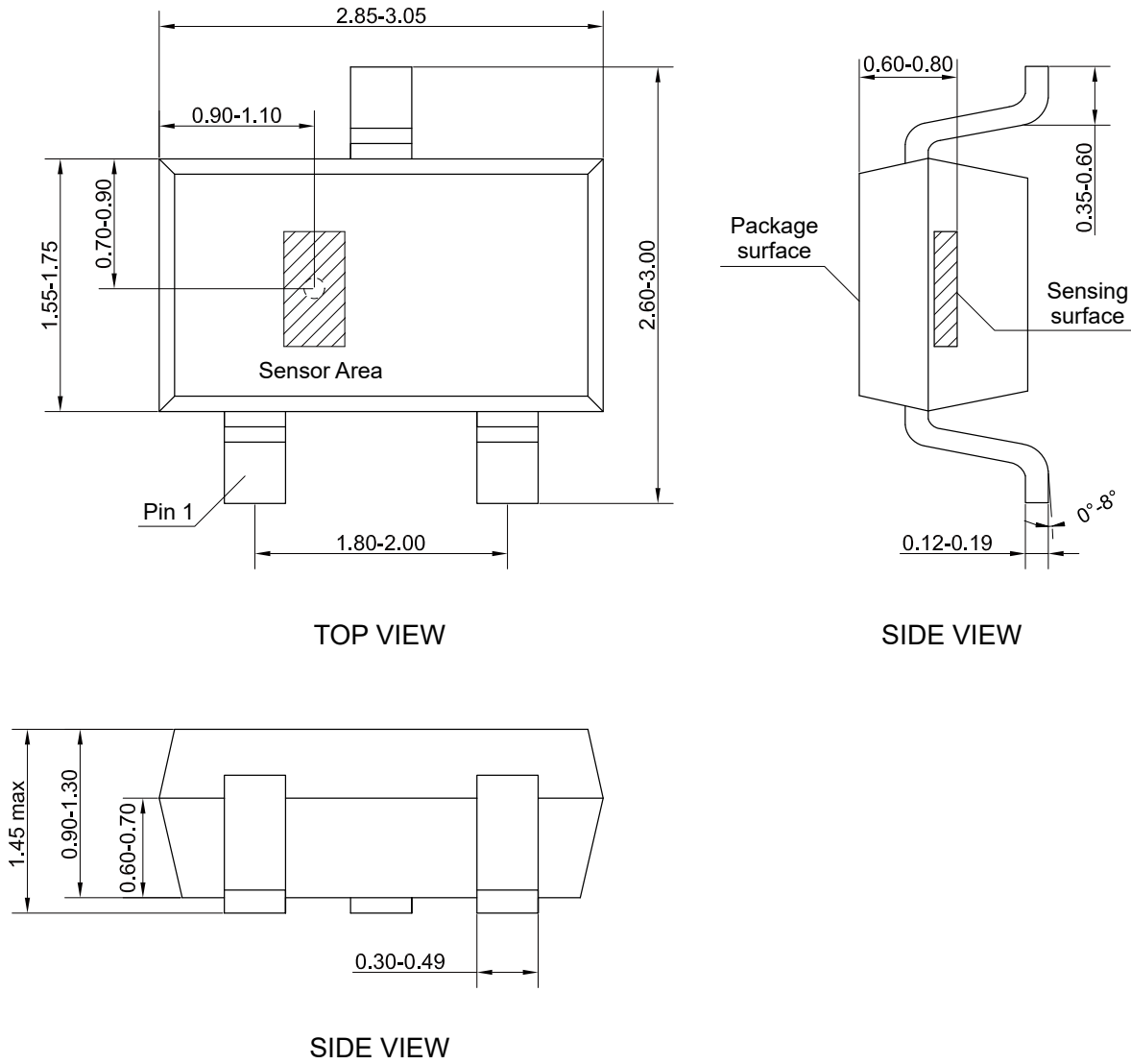

Figure 25. Package outline of SOT23-3 (unit: mm)

TO92S Package

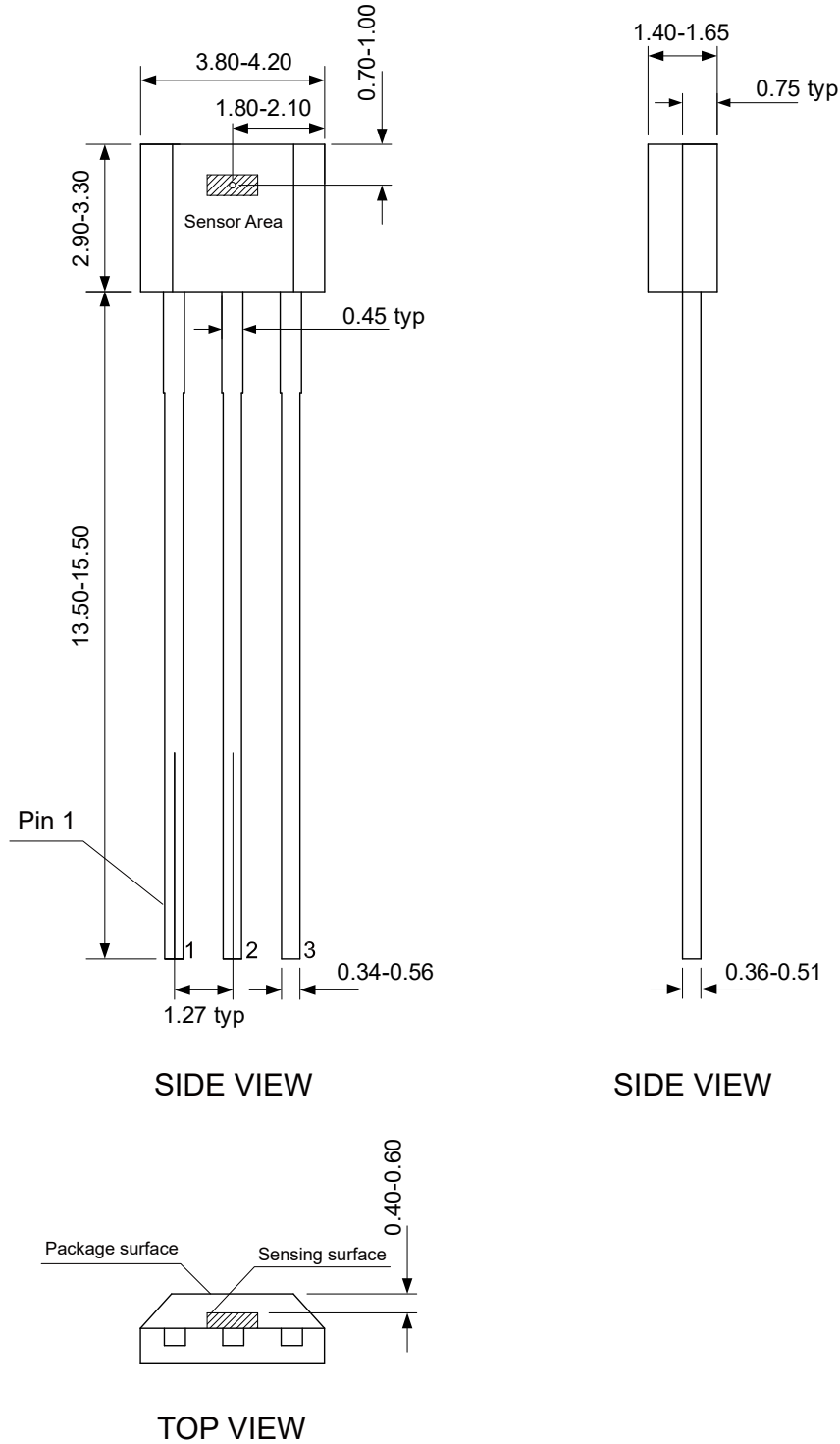

Figure 26. Package outline of TO92S (unit: mm)

Copyright © 2026 by MultiDimension Technology Co., Ltd.

Information furnished herein by MultiDimension Technology Co., Ltd. (hereinafter MDT) is believed to be accurate and reliable. However, MDT disclaims any and all warranties and liabilities of any kind, with respect to any examples, hints or any performance or use of technical data as described herein and/or any information regarding the application of the product, including without limitation warranties of non-infringement of intellectual property rights of any third party. This document neither conveys nor implies any license under patent or other industrial or intellectual property rights. Customer or any third-party must further determine the suitability of the MDT products for its applications to avoid the applications default of customer or third-party. MDT accept no liability in this respect.

MDT does not assume any liabilities of any indirect, incidental, punitive, special or consequential damages (including without limitation of lost profits, lost savings, business interruption, costs related to the removal or replacement of any products or rework charges) whether or not such damages are based on tort (including negligence), warranty, breach of contract or any other legal theory. Notwithstanding any damages that customer might incur for any reason whatsoever, MDT's aggregate and cumulative liability towards customer for the products described herein shall be limited in accordance with the terms and conditions of commercial sale of MDT.

Absolute maximum ratings are the extreme limits the device will withstand without damage to the MDT product. However, the electrical and mechanical characteristics are not guaranteed as the maximum limits (above recommended operating conditions) are approached. MDT disclaims any and all warranties and liabilities of the MDT product will operate at absolute maximum ratings.

Specifications may change without notice.

Please download latest document from our official website www.dowaytech.com/en.

Recycling

The product(s) in this document should be disposed of at the end of the product(s) life using a qualified waste management company for recycling in accordance with local regulations.



No.2 Guangdong Road, Zhangjiang Free Trade Zone, Jiangsu, China

Web: www.dowaytech.com/en E-mail: info@dowaytech.com

